

# FEA of A Tire Iron

Kyle Parker



**Figure 1 - Tire Iron Modeled in NX5**

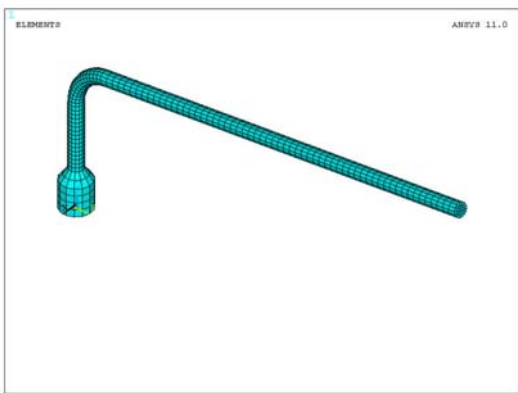

Figure 2 - Elements

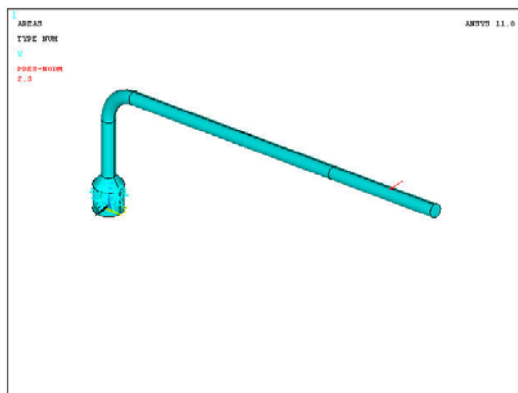

Figure 3 - Applied Forces

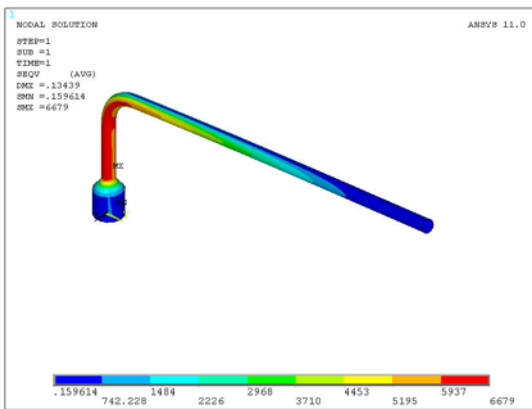

Figure 4 - 10 lb/ft Torque

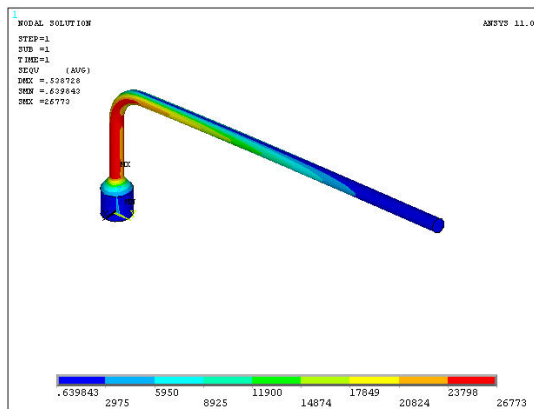

Figure 5 - 40 lb/ft Torque

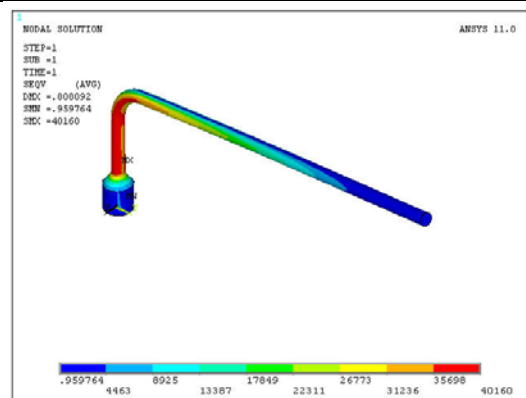

Figure 6 - 60 lb/ft Torque

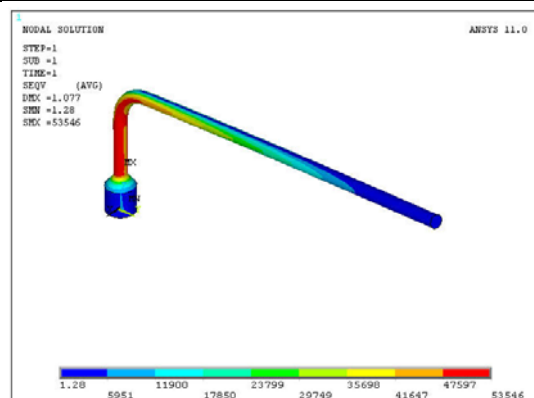

Figure 7 - 80 lb/ft Torque

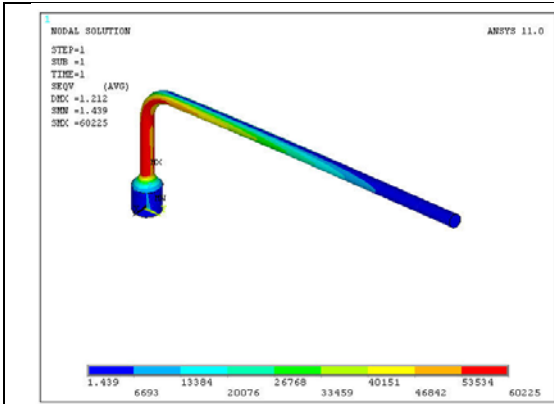

Figure 8 - 90 lb/ft Torque

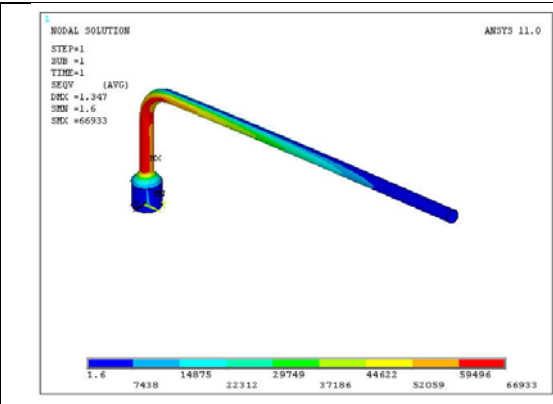

Figure 9 - 100 lb/ft Torque

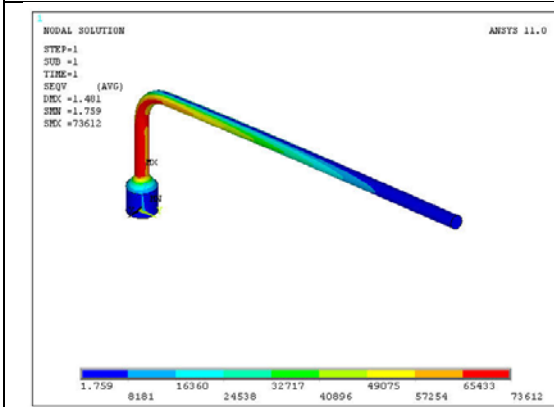

Figure 10 - 110 lb/ft Torque

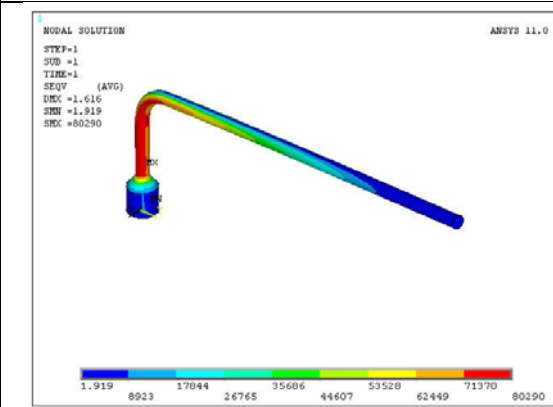

Figure 11 - 120 lb/ft Torque

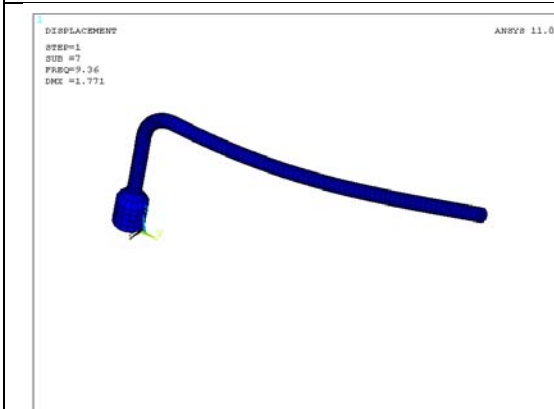

Figure 12 - Mode 1

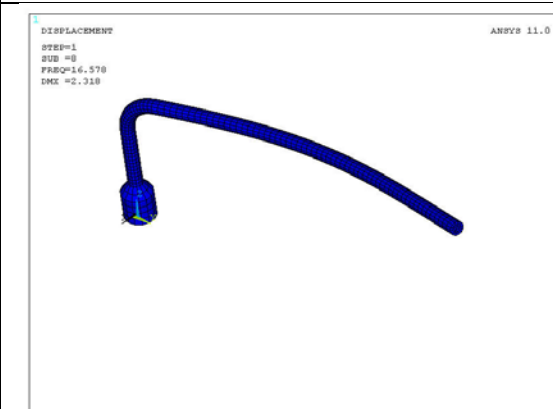

Figure 13 - Mode 2

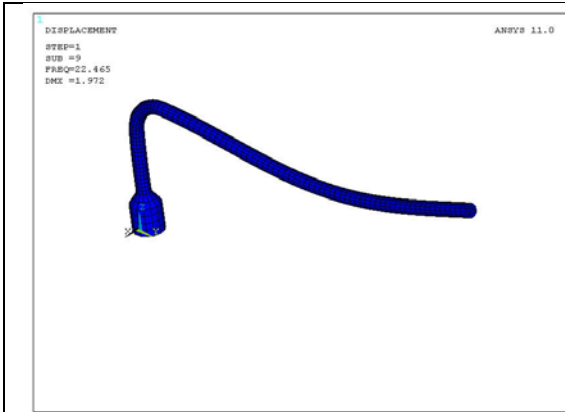

Figure 14 - Mode 3

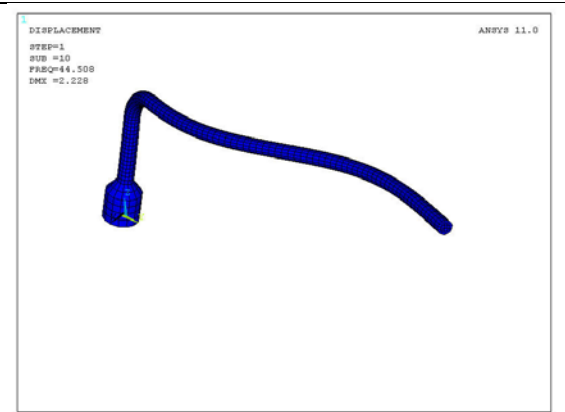

Figure 15 - Mode 4

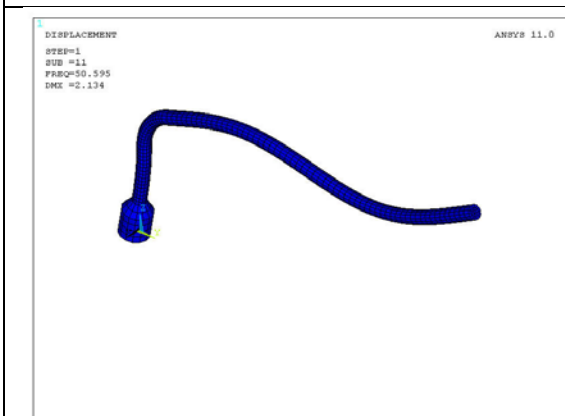

Figure 16 - Mode 5

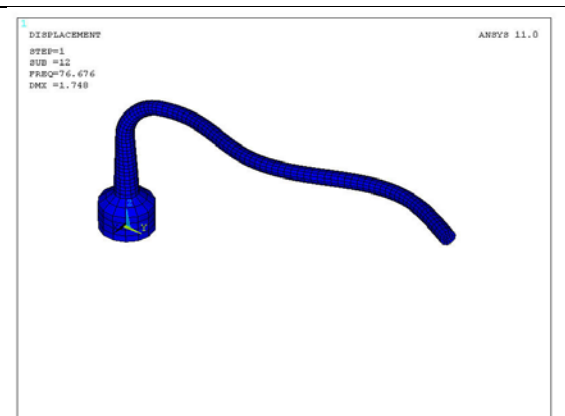

Figure 17 - Mode 6

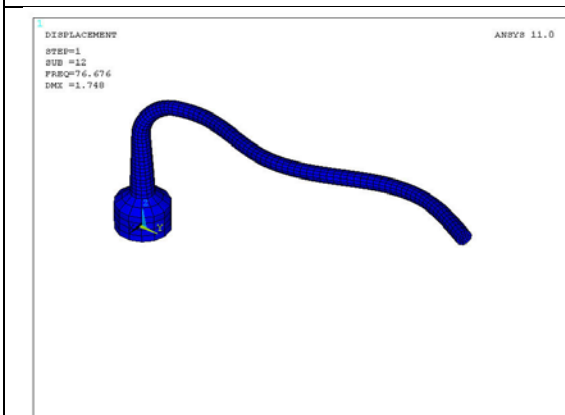

Figure 18 - Mode 7

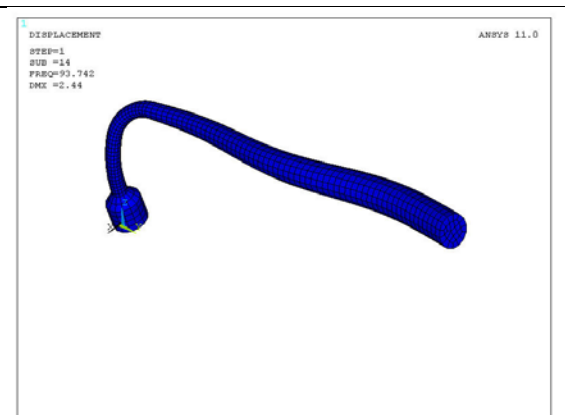

Figure 19 - Mode 8